



**Nexspan™**

ENHANCING THE QUALITY OF LIFE

## **The Tool Box**

To place an order for any of the above products, please contact a sales representative at 678.578.7800 or email at [orders@nexspan.com](mailto:orders@nexspan.com)

Additional device holders are available, please inquire if you have a specific requirement

## SYSTEM TOOLS

Adapters.....	1
Heavy Duty Equipment Rails.....	1
Light Duty Equipment Rails.....	2
Mounting Hardware.....	2
Equipment Shelves and Monitor Mounts.....	3, 4
Work Surfaces.....	5
Supply Management.....	5, 6
Infection Control.....	6, 7
Lighting.....	7
Infusion Management.....	8
Diagnostic Equipment Management.....	9
Mobile Solutions.....	10
General Purpose Accessories.....	10, 11
Pole Mounting Accessories.....	11

## MEDICAL GAS EXPANSION TOOLS

Ventilator Manifolds.....	12
Oxygen Gas Blocks.....	12, 13
Oxygen Outlet Splitter Blocks.....	13
Oxygen Hoses.....	14
Air Gas Blocks.....	15
Air Outlet Splitter Blocks.....	16
Air Hoses.....	16, 17
Vacuum Gas Blocks.....	17, 18
Vacuum Outlet Splitters.....	18
Vacuum Hoses.....	19
Headwalls.....	20
IV Transfer.....	21

# SYSTEM TOOLS

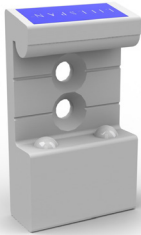

1001-001



1001-010

## Adapters

- Provides secure attachment of medical equipment to Lifespan Equipment Rail.
- Snap on-off design allows easy repositioning of equipment.
- Simple Allen screw provides option for locking devices onto a rail.

- 1001-000 **Single, Snap-Action, Blank**
- 1001-001 **Single, Snap-Action, Drilled and Countersunk** (2 Vertical holes)
- 1001-002 **Single, Snap-Action, Drilled and Countersunk** (2 Horizontal holes)
- 1001-003 **Single, Snap-Action, Drilled and Tapped 10/32"** (2 Vertical holes)
- 1001-004 **Single, Snap Action, Drilled and Tapped 10/32"** (2 Horizontal holes)
- 1001-005 **Single, Snap-Action, Drilled and Countersunk** (One hole)
- 1001-006 **Single, Snap-Action, Drilled and Tapped** (One 10/32" hole)
- 1001-007 **Single, Snap-Action, Drilled and Tapped** (Three 10/32" holes)
- 1001-010 **Double, Snap-Action, Drilled and Countersunk** (2 Vertical holes)
- 1001-011 **Double, Snap-Action, Drilled and Countersunk** (4 holes)
- 1001-012 **Double, Snap-Action, Drilled and Countersunk** (2 Horizontal holes)
- 1001-013 **Double, Snap-Action, Drilled and Tapped for M6 screw** (2 Horizontal holes)
- 1001-014 **Double, Snap-Action, Drilled and Tapped** (Four 10/32" holes)

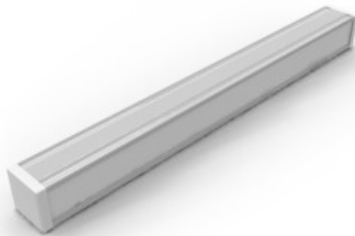

1002-012



1002-P01



1002-P02

## Heavy Duty Equipment Rails

- Includes end caps and decorative inlay.
- Supports medical equipment that normally takes up floor or cabinet space.
- Organizes equipment and supplies safely; protecting personnel and hospital assets.
- System is flexible and expandable to meet future needs.
- Improves staff productivity by giving control of device to end user.

- 1002-012 **1'**
- 1002-024 **2'**
- 1002-036 **3'**
- 1002-048 **4'**
- 1002-060 **5'**
- 1002-072 **6'**
- 1002-084 **7'**
- 1002-096 **8'**
- 1002-108 **9'**
- 1002-120 **10'**
- 1002-P01 **End Cap, Hard Plastic**
- 1002-P02 **Joiner**
- 1002-P04 **Inlay (1')**

To place an order for any of the above products, please contact a sales representative at 678.578.7800 or email at [orders@nexspan.com](mailto:orders@nexspan.com)

## Light Duty Equipment Rails

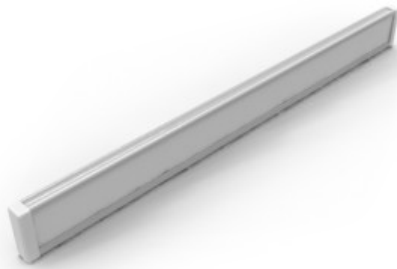

1003-012



1003-P01



1003-P02

- Includes end caps and decorative inlay.
- Not intended for wall applications.
- Utilized as attachment on other manufactures equipment only.

1003-012 **1'**1003-024 **2'**1003-036 **3'**1003-048 **4'**1003-060 **5'**1003-072 **6'**1003-084 **7'**1003-096 **8'**1003-108 **9'**1003-120 **10'**1003-P01 **End Cap, Hard Plastic**1003-P02 **Joiner**1003-P04 **Inlay (1')**1003-P05 **End Cap, Vinyl**

## Mounting Hardware



1004-P05



Mounting Hardware

- Provides safe mounting of rail to a variety of surfaces.

1004-HR1 **Flush Mount, Hardware for Heavy Duty Rail on HR Vertical Channel** (qty 2)1004-P01 **Flush Mount, Heavy or Light Duty Rail, Metal Studs or Backer** (qty 1)1004-P02 **Flush Mount, Heavy and Light Duty Rail, Drywall** (qty 1)1004-P03 **Flush Mount, Heavy and Light Duty Rail, Masonry** (qty 1)1004-P04 **Stand-Off, Heavy Duty Rail, Metal Studs or Backer** (qty 1)1004-P05 **Stand-Off, Heavy Duty Rail, Drywall** (qty 1)1004-P06 **Stand-Off, Heavy Duty Rail, Masonry** (qty 1)1004-P07 **Stand-Off, Light Duty Rail, Metal Studs or Backer** (qty 1)1004-P08 **Stand-Off, Light Duty Rail, Drywall** (qty 1)1004-P09 **Stand-Off, Light Duty Rail, Masonry** (qty 1)1004-P14 **Pedestal, for Mounting Equipment Rail** (30" High with a 4" x 6" Base)

To place an order for any of the above products, please contact a sales representative at 678.578.7800 or email at [orders@nexspan.com](mailto:orders@nexspan.com)

## Equipment Shelves and Monitor Mounts

- A variety of sizes for convenient placement of medical devices.

1009-001 **Shelf, Flat** (10" x 8")

1009-002 **Shelf, Flat** (10" x 13")

1009-003 **Shelf, Flat** (13" x 13")

1009-004 **Shelf, Flat** (19" x 13")

- Positions equipment for optimum visibility.

1009-005 **Shelf, Angled** (8" x 8")

1009-006 **Shelf, Angled** (13" x 8")

- Securely holds a variety of equipment items for transport purposes.

1009-014 **Shelf, Angled with Strap** (8" x 8")

1009-015 **Shelf, Angled with Strap** (13" x 8")

- Allows shelf to be folded out of the way when not in use.

1009-007 **Shelf, Hinged** (9" x 12")

1009-008 **Shelf, Hinged** (13-1/2" x 10")

1009-009 **Shelf, Hinged** (17" x 12")

- Classic design for bedside procedures.

- Hinged design allows tray to be folded out of the way when not in use.

1009-010 **Mayo Tray, Hinged** (13-5/8" x 9-3/4")

1009-011 **Mayo Tray, Hinged** (17-5/8" x 11-5/8")

- Classic design for bedside procedures.

1009-012 **Mayo Tray, Fixed** (13-5/8" x 9-3/4")

1009-013 **Mayo Tray, Fixed** (17-1/8" x 11-5/8")



1009-001

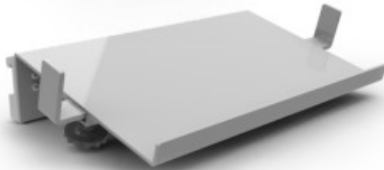

1009-006

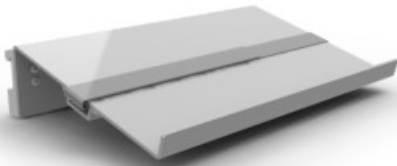

1009-015



1009-007



1009-010



To place an order for any of the above products, please contact a sales representative at 678.578.7800 or email at [orders@nexspan.com](mailto:orders@nexspan.com)

## Equipment Shelves and Monitor Mounts *(continued)*

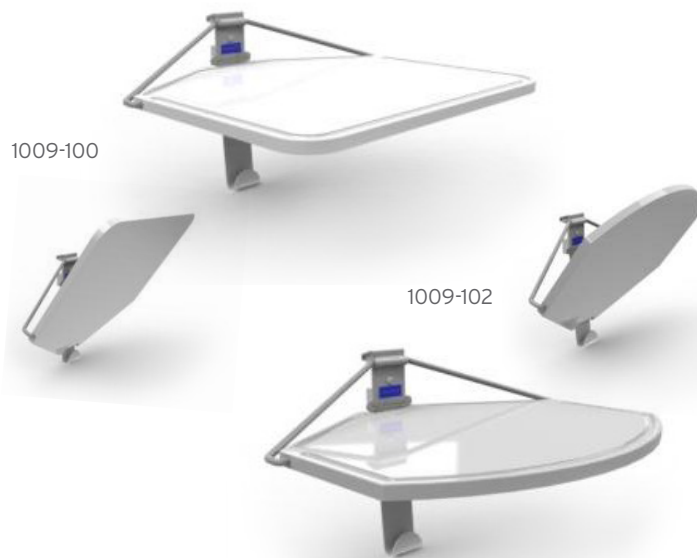

- Single hand use shelf for a variety of procedure and equipment applications.

1009-100 **Shelf, WORXX Station Fold Up**  
(10" x 15", Rail Mounting)

1009-101 **Shelf, WORXX Station Fold Up**  
(10" x 15", 1-1.5" Pole Mounting)

1009-102 **Shelf, Compact WORXX Station Fold Up**  
(8" x 12", Rail Mounting)

1009-103 **Shelf, Compact WORXX Station Fold Up**  
(8" x 12", 1-1.5" Pole Mounting)

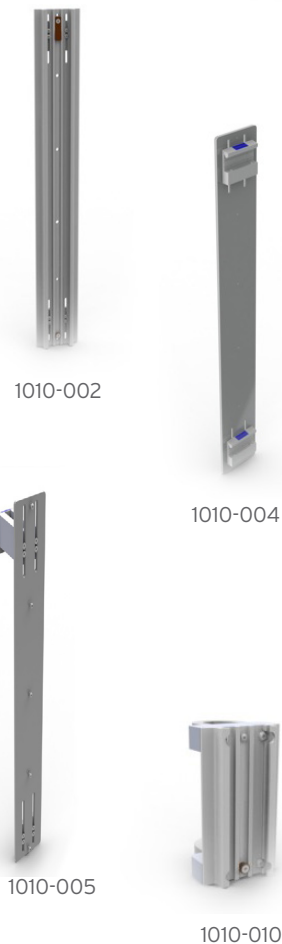

- Provides secure attachment of monitor.
- GCX arm provided by others.

1010-001 **GCX Channel, with Adapters** (16-24" Span between Rail)

1010-002 **GCX Channel, with Adapters** (20-28" Span between Rail)

1010-003 **GCX Adapter Plate (GCX by others)** (16-24" Span between Rail)

1010-004 **GCX Adapter Plate (GCX by others)** (20-28" Span between Rail)

1010-005 **GCX Adapter Plate (GCX by others)** (16-24" Span between Rail and MGR)

1010-006 **GCX Channel with Adapters** (16-24" Span between Rail and MGR)

1010-010 **GCX Channel** (7", 38mm Pole Mounting)

1010-010L **GCX Channel** (7", 38mm Pole Mounting, on Lifespan Headwalls)

1010-012 **GCX Channel** (25", Wall Mounting)

1010-013 **GCX Channel** (31", Wall Mounting)

1010-016 **GCX Adapter Plate (GCX by others)**  
(16-24" between Flush Mounted Heavy Duty Rail, Spanning a MGR)

1010-017 **GCX Adapter Plate (GCX by others)**  
(20-28" between Flush Mounted Heavy Duty Rail, Spanning a MGR)

1010-018 **GCX Channel with Adapters**  
(16-24" between Flush Mounted Heavy Duty Rail, Spanning a MGR)

1010-019 **GCX Channel with Adapters**  
(20-28" between Flush Mounted Heavy Duty Rail, Spanning a MGR)

To place an order for any of the above products, please contact a sales representative at 678.578.7800 or email at [orders@nexspan.com](mailto:orders@nexspan.com)

## Work Surfaces

- Component based system of work surfaces and storage drawers.

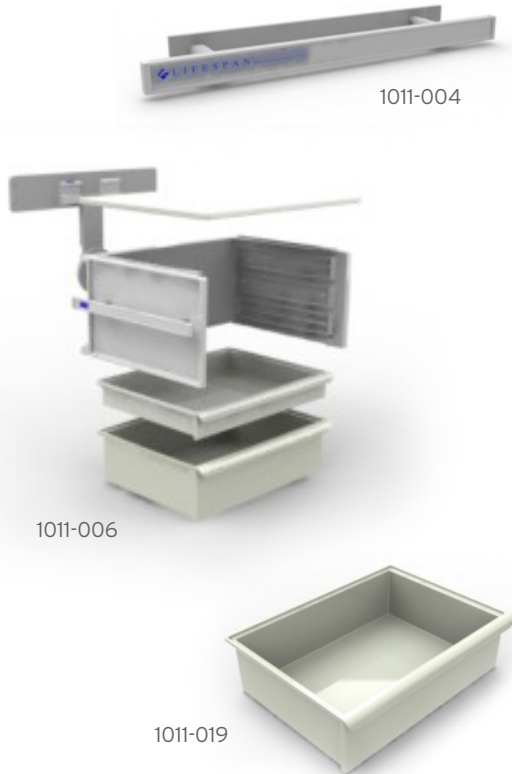

- 1011-004 **Rail Kit, C-Frame Side, Light Duty Rail with Stand Offs**
- 1011-004B **Rail Kit, C-Frame Side, Heavy Duty Rail, Flush Mount**
- 1011-005 **C-Frame Mounting Kit, for Equipment Rail**  
(Includes adapter rail, two side rails, wall stand-off and mounting hardware)
- 1011-005A **C-Frame Mounting Adapter Rail Only, for Heavy Duty Rail Mounting**
- 1011-006 **C-Frame, with A and B Drawers, Standard Top, Mounting Kit to Equipment Rail**
- 1011-007 **C-Frame, with A and B Drawers, Extended Top, Mounting Kit to Equipment Rail**
- 1011-015 **C-Frame (22" x 17" x 10")**
- 1011-016 **Counter Top, Extended (32" Wide)**
- 1011-017 **Standard Counter Top for C-Frame**
- 1011-018 **Drawer A, Non-Lock (3" High)**
- 1011-019 **Drawer B, Non-Lock (6" High)**
- 1011-020 **Drawer C, Non-Lock (9" High)**
- 1011-021 **Drawer A, Lockable Front (3" High)**
- 1011-022 **Drawer B, Lockable Front (6" High)**
- 1011-023 **Drawer C, Lockable Front (9" High)**

## Supply Management

- Provides organization for small supplies.
- Provides user tools for "lean" process improvement.

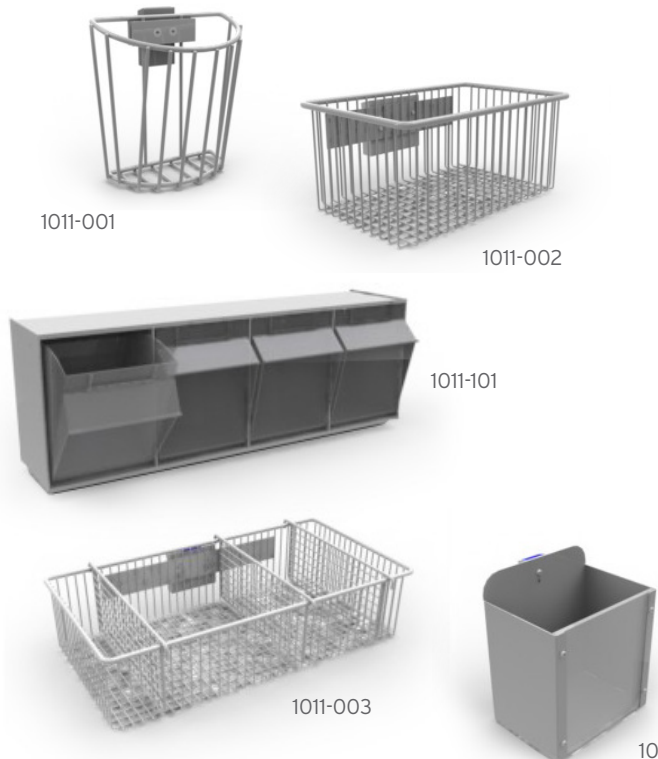

- 1011-001 **Basket, Utility**
- 1011-002 **Basket, Fixed (10" x 6" x 4")**
- 1011-003 **Basket, Fixed (18" x 9" x 4", with 3 Dividers)**
- 1011-100 **Bin, Storage, Tilt Out (3 Bin, Rail Mounted)**
- 1011-101 **Bin, Storage, Tilt Out (4 Bin, Rail Mounted)**
- 1011-102 **Bin, Storage, Tilt Out (5 Bin, Rail Mounted)**
- 1011-103 **Bin, Storage, Tilt Out (6 Bin, Rail Mounted)**
- 1013-004 **Holder, Resuscitator, Universal style**
- 1013-005 **Holder, Catheter, Short (7" x 5" x 7")**
- 1013-006 **Holder, Catheter, Long (6" x 4" x 18")**

To place an order for any of the above products, please contact a sales representative at 678.578.7800 or email at [orders@nexspan.com](mailto:orders@nexspan.com)



## Supply Management (continued)



1013-014



1013-013



1013-030



1011-114

- 1013-013 **Holder, Utility Hook** (1 Hook)
- 1013-014 **Holder, Utility Hook** (3 Hook)
- 1013-029 **Holder** (6 Clip Organizer)
- 1013-030 **Holder** (4 Clip Organizer)
- 1013-033 **Holder** (3 Clip Organizer)
- 1013-113 **Holder, Utility Hook** (1 Hook with 3 Clips)
- 1013-114 **Holder, Utility Hook** (3 Hook with 9 Clips)



1018-S01



1018-S03



1013-061

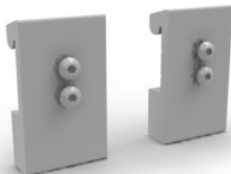

1013-075

## Infection Control

- Eliminates excessive holes in the wall when contracts change.
- Infection control devices can be located where best suited by users.
- Supports infection control compliance initiatives.

- 1018-S01 **Holder, Rail Mount:** Steris Germicidal Surface Wipes 1608-65
- 1018-S02 **Holder, Rail Mount:** Steris 17oz All Care 6399-90
- 1018-S03 **Holder, Rail Mount:** Steris 9oz All Care 6399-36
- 1018-S04 **Holder, Rail Mount:** Steris Multi Use Hand Pump Dispenser 1307-Q5 with Wall Bracket 1308-Q7
- 1018-S05 **Holder, Rail Mount:** Steris Cal-Stat
- 1018-S06 **Holder, Rail Mount:** Steris SN Sure Gel
- 1013-050 **Holder, Rail Mount:** PDI Sani Cloth, Metal Holder by others
- 1013-055 **Holder, Rail Mount:** 3M Avagard D Hand Antiseptic with Moisturizers
- 1013-060 **Holder, Rail Mount:** 8oz Medline Epi-Clenz MSC097040
- 1013-061 **Holder, Rail Mount:** MedLine Hand Pump CM-040
- 1013-112 **Holder, Rail Mount:** Universal Soap, Lotion, Sanitizer
- 1013-075 **Holder, Rail Mount:** Tri Fold Towel Dispenser

To place an order for any of the above products, please contact a sales representative at 678.578.7800 or email at [orders@nexspan.com](mailto:orders@nexspan.com)



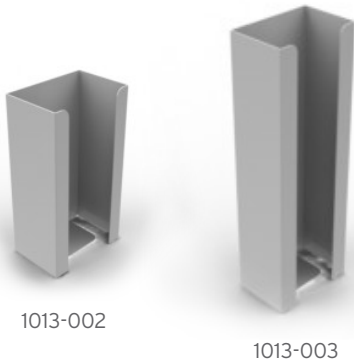

1013-002

1013-003

## Infection Control (continued)

- 1013-002 **Holder:** Glove Box, 1 Box  
 1013-003 **Holder:** Glove Box, 2 Boxes  
 1013-034 **Holder, Adjustable Position:** Glove Box, 3 Boxes  
 1013-009 **Holder:** Sharps Container, Universal Style  
 1013-039 **Holder:** Large Kendall Sharps Container  
 1013-041 **Holder:** Standard Kendall Sharps  
 1013-040 **Holder:** Daniels Sharpsmart



1013-034

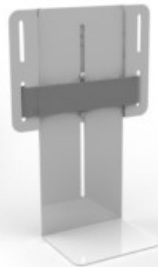

1013-009

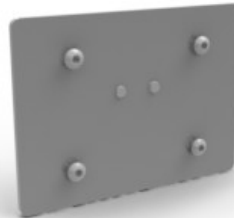

1013-040



1013-041



1015-003

1015-004

1015-015

## Lighting

- Provides flexible attachment of user controlled lighting.

- 1015-001 **Holder:** Luxo Lamp  
 1015-003 **Holder:** Waldman, Euro Style Lamp  
 1015-004 **Light, Task:** Waldmann Halux #50SX  
 1015-015 **Light, 1.5" Pole Mount:** Halux, Isis, Single, 50w, 120v, 38mm  
 1015-020 **Light, GCX Channel Mount:** Halux, Isis, Single, 50w, 120v

To place an order for any of the above products, please contact a sales representative at 678.578.7800 or email at [orders@nexspan.com](mailto:orders@nexspan.com)

## Infusion Management

- Safely organizes infusion equipment.
- Adaptable to changing technologies and patient care protocols.
- Eliminates floor stands.

- 1013-024 **Holder, Post** (1" Diameter x 4" High)
- 1014-001 **Infusion Pump, Single Holder, Single Rail Mount** (36" x 20" Pole, 3 Hooks)
- 1014-002 **Infusion Pump, Dual Swivel Holder, Single Rail Mount** (36" x 20" Pole, 3 Hooks)
- 1014-003 **Infusion Pump, Fixed Single Holder, Dual Rail Mount** (36" x 20" Pole, 3 Hooks)
- 1014-004 **Infusion Pump, Fixed Single Holder, Dual Rail Mount** (48" x 20" Pole, 3 Hooks)
- 1014-005 **Infusion Pump, Fixed Single Holder, Single Rail Mount** (16" x 10" Pole, 3 Hooks)
- 1014-006 **Infusion Pump, Fixed Single Holder, Single Rail Mount** (24" x 15" Pole, 3 Hooks)
- 1014-007 **Infusion Pump, Fixed Single Holder, Single Rail Mount** (30" x 20" Pole, 3 Hooks)
- 1014-008 **IV Swing Arm** (12" x 20", 1.5" Pole Mount, Arm Only)
- 1014-010 **IV Swing Arm, Single Articulation** (12", for 1-1/2" Pole Mount)
- 1014-011 **IV Swing Arm** (12" x 20", 1.5" Pole Mount with 36" IV Pole)
- 1014-012 **IV Swing Arm** (12" x 20", GCX Mounting with 36" IV Pole)
- 1014-P06 **Holder, Single Pole** (36" Long with 20" IV Pole and 3-hook hanger)
- 1014-P07 **Holder, Single** (1" IV Pole Holder, Rail Mount with Snap Action Adapter for Rail Mounting)
- 1014-P11 **Holder, Infusion Pump Mount** (1" Diameter x 6" high with Snap Action Adapter for Rail Mounting)



To place an order for any of the above products, please contact a sales representative at 678.578.7800 or email at [orders@nexspan.com](mailto:orders@nexspan.com)

## Diagnostic Equipment Management

- Easy conversion of diagnostic equipment to Lifespan Equipment Rail.

- 1010-009 **Adapter, Rail Mounting:** Dynamap, NIVP monitor
- 1012-002 **Device, Blood Pressure, Tyco-Aneroid:**  
Welch Allyn, Model 509 with Adapter and Cuff Holder
- 1012-P02 **Mounting Kit, Tyco-Aneroid:** WelchAllyn, Model 509
- 1012-P03 **Holder, Cuff (U-Shaped)  
with Generic BP Mount and Hardware**
- 1012-P04 **Mounting Kit, Cuff Basket (by others)**
- 1012-P05 **Mounting Kit, Tyco-Aneroid:** WelchAllyn, Model 767
- 1013-010 **Holder, Ophthalmoscope:** Welch Allyn 747 Series
- 1013-011 **Holder, Ophthalmoscope:** Welch Allyn 767 Series
- 1013-012 **Holder, Speculum Container**
- 1013-045 **Holder, Thermometer:** Welch Allyn Sure Temp
- 1013-016 **Holder, Universal Manometer**
- 1013-018 **Holder, Magnahelic Gauge**
- 1013-023 **Holder, Bird Blender**
- 1013-025 **Holder, Pole Mount, Transducer**
- 1013-036 **Holder, Rail Mount:** Neopuff

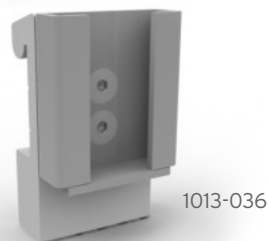
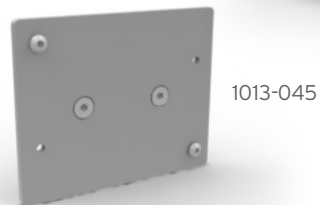
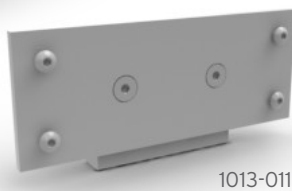
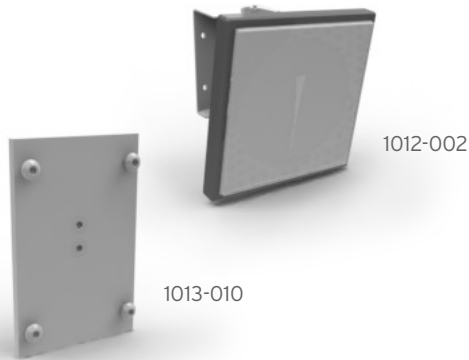

To place an order for any of the above products, please contact a sales representative at 678.578.7800 or email at [orders@nexspan.com](mailto:orders@nexspan.com)

## Mobile Solutions

- Convenient solutions to manage surge and mass casualty situations.

1025-001 **Cart, Memo 2: 3 Parallel Rails**

1025-001S **Cart, Memo 2: Short with C-Frame Adapter**

1025-002 **Cart, Memo 2: 2 Parallel Rails, 2 Swivel Rails and 1 Adapter Rail for Mounting C-Frame**

1025-015 **Cart, Memo 4: 3 Oxygen "H" Tanks with Integrated Equipment Management**

1025-HBV **Cart, Memo 4: 4 Layers of integrated equipment management and 17" Power Rail**



1025-001



1025-002



1025-015



1025-HBV

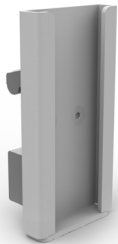

1008-001



1013-001

## General Purpose Accessories

- A variety of unique adapters for specialty applications.

1008-001 **Slide, Vacuum Bottle**

1013-001 **Holder, Chart**

1013-007 **Holder, Hose, 3 Clip**

1013-008 **Holder, Hose, 6 Clip**

1013-015 **Holder, "E" Cylinder Bottle**



1013-015



1013-007

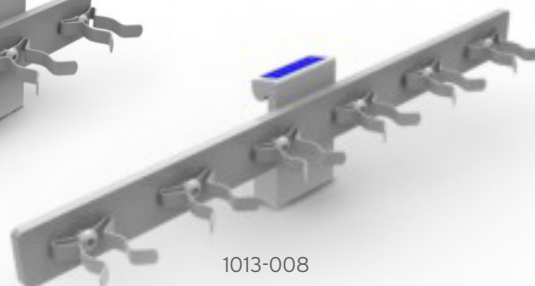

1013-008

To place an order for any of the above products, please contact a sales representative at 678.578.7800 or email at [orders@nexspan.com](mailto:orders@nexspan.com)



1013-020

## General Purpose Accessories (continued)

1013-020 **Holder, Waste Basket and Universal Holder**

1013-021 **Holder, Waste Basket**

1013-022 **Holder, Pole, Universal**

1013-026 **Holder, Cord Wrap**

1013-027 **Holder, Telephone Mounting**

1013-028 **Holder, Flex Arm Respiratory Circuit**

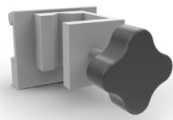

1013-022



1013-027

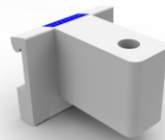

1013-028

## Pole Mounted Accessories

• Accessories to provide expansion on existing carts and other medical equipment (incubator, anesthesia machines and ventilators.)



1018-001

1018-001 **Parallel Rail, 1 B, 1.5" Tube**

1018-002 **Parallel Rail, 1.5 B, 1.5" Tube**

1018-003 **Double Swivel Rail for 1.5" Tube**

1018-004 **Compact Rail for 1.5" Tube**

1018-005 **Compact Rail for 1" Tube**

1013-019 **Rail, Light Duty, 8", Pole Mounting**

1009-P01 **Universal Pole Clamp up to 1.5", Clamp Only**

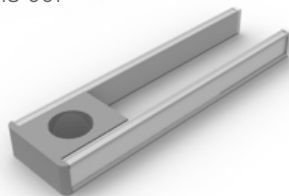

1018-003



1018-005



1018-004

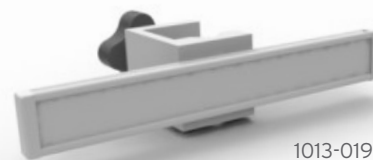

1013-019

To place an order for any of the above products, please contact a sales representative at 678.578.7800 or email at [orders@nexspan.com](mailto:orders@nexspan.com)

# MEDICAL GAS EXPANSION

- Unique compact design saves horizontal rail space.
- All gas blocks pre-drilled for side check valves allowing for future expansion.
- Durable finish resists scratches, stains and cleaning solutions.

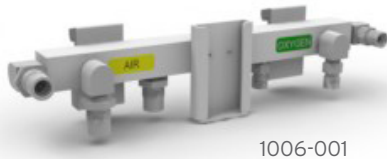

1006-001



1006-002

## Ventilator Manifolds

- Organizes ventilator connections for safe positive connections.
- Provides separation between respiratory and nursing functions.

- 1006-001 **Manifold, Air/Oxygen:** 2 Air DISS and 2 Oxygen DISS with Blender Bracket
- 1006-002 **Manifold, Air/Oxygen:** 3 Air DISS and 3 Oxygen DISS with Blender Bracket
- 1006-003 **Manifold, Air/Oxygen:** 2 Air and 2 Oxygen Chemetron Quick-Connectors with Blender Bracket
- 1006-004 **Manifold, Air/Oxygen:** 2 Air and 2 Oxygen Ohmeda Quick-Connectors with Blender Bracket



1105-001

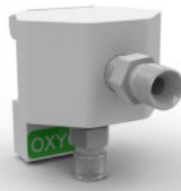

1105-002



1105-012



1105-003



1105-004

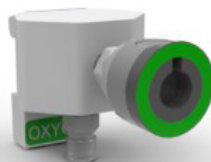

1105-005

## Oxygen Gas Blocks

- 1105-001 **(1) 1/8" NPT Front**
- 1105-011 **(1) 1/8" NPT Front, DISS Side**
- 1105-002 **(1) DISS Front**
- 1105-012 **(1) DISS Front, DISS Side**
- 1105-003 **(1) Ohmeda Quick Connect Front**
- 1105-013 **(1) Ohmeda Quick Connect Front, DISS Side**
- 1105-004 **(1) Chemetron Quick Connect Front**
- 1105-014 **(1) Chemetron Quick Connect Front, DISS Side**
- 1105-005 **(1) Puritan Quick Connect Front**
- 1105-015 **(1) Puritan Quick Connect Front, DISS Side**

To place an order for any of the above products, please contact a sales representative at 678.578.7800 or email at [orders@nexspan.com](mailto:orders@nexspan.com)



1205-001

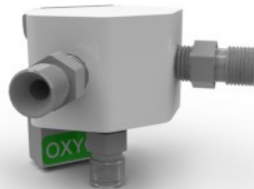

1205-002



1205-012



1205-003

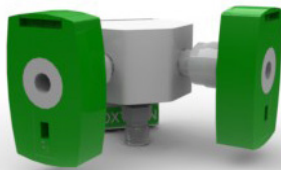

1205-004



1205-005

### Oxygen Gas Blocks (continued)

- 1205-001 (2) 1/8" NPT Front
- 1205-011 (2) 1/8" NPT Front, DISS Side
- 1205-111 (2) 1/8" NPT Front, (2) DISS Side, Top Feed
- 1205-002 (2) DISS Front
- 1205-012 (2) DISS Front, DISS Side
- 1205-003 (2) Ohmeda Quick Connect Front
- 1205-013 (2) Ohmeda Quick Connect Front, DISS Side
- 1205-004 (2) Chemetron Connect Front
- 1205-014 (2) Chemetron Quick Connect Front, DISS Side
- 1205-005 (2) Puritan Quick Connect Front
- 1205-015 (2) Puritan Quick Connect Front, DISS Side

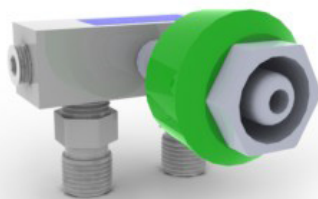

1006-017

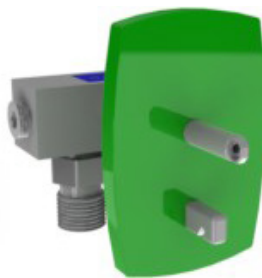

1006-009

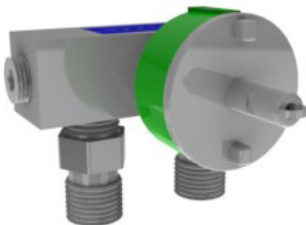

1006-007



1006-019

### Oxygen Outlet Splitter Blocks

- 1006-017 DISS to (2) DISS Outlets
- 1006-009 Chemetron Quick Connect to (2) DISS Outlets
- 1006-007 Ohmeda Quick Connect to (2) DISS Outlets
- 1006-019 Puritan Quick Connect to (2) DISS Outlets

To place an order for any of the above products, please contact a sales representative at 678.578.7800 or email at [orders@nexspan.com](mailto:orders@nexspan.com)



## Oxygen Hoses



1007-301

1007-001 **DISS to DISS Handnut Straight**  
(24", Clear, Non-Conductive)

1007-301 **DISS Straight to DISS Handnut with 90° Fitting**  
(24", Clear, Non-Conductive)

1007-004 **DISS to Ohmeda Style Quick Connect with 90° Fitting**  
(24", Clear, Non-Conductive)

1007-005 **DISS to Chemetron Style Quick Connect with 90° Fitting**  
(24", Clear, Non-Conductive)

1007-006 **DISS to Puritan Style Quick Connect with 90° Fitting**  
(24", Clear, Non-Conductive)

1007-101 **DISS to DISS Handnut Straight** (36", Clear, Non-Conductive)

1007-311 **DISS Straight to DISS Handnut with 90° Fitting**  
(36", Clear, Non-Conductive)

1007-104 **DISS to Ohmeda Style Quick Connect with 90° Fitting**  
(36", Clear, Non-Conductive)

1007-105 **DISS to Chemetron Style Quick Connect with 90° Fitting**  
(36", Clear, Non-Conductive)

1007-106 **DISS to Puritan Style Quick Connect with 90° Fitting**  
(36", Clear, Non-Conductive)

1007-120 **DISS to DISS with 90° Fitting** (36", Clear, Non-Conductive)

1007-121 **DISS to DISS Straight** (36", Clear, Non-Conductive)

1007-201 **DISS to DISS Handnut Straight** (48", Clear, Non-Conductive)

1007-220 **DISS to DISS with 90° Fitting** (48", Clear, Non-Conductive)

1007-321 **DISS Straight to DISS Handnut with 90° Fitting**  
(48", Clear, Non-Conductive)

1007-204 **DISS to Ohmeda Style Quick Connect with 90° Fitting**  
(48", Clear, Non-Conductive)

1007-205 **DISS to Chemetron Style Quick Connect with 90° Fitting**  
(48", Clear, Non-Conductive)

1007-206 **DISS to Puritan Style Quick Connect with 90° Fitting**  
(48", Clear, Non-Conductive)



1007-004



1007-121



1007-205

To place an order for any of the above products, please contact a sales representative at 678.578.7800 or email at [orders@nexspan.com](mailto:orders@nexspan.com)

## Air Gas Blocks



1125-001

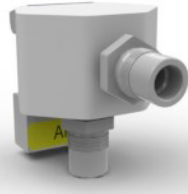

1125-002

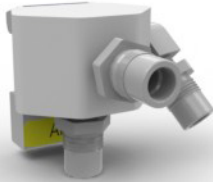

1125-012

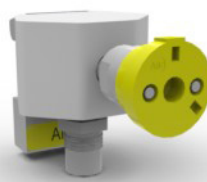

1125-003

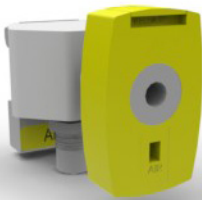

1125-004

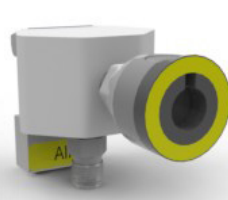

1125-005

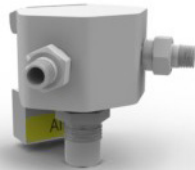

1225-001

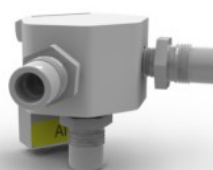

1225-002



1225-012



1225-003

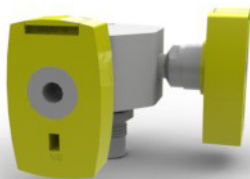

1225-004

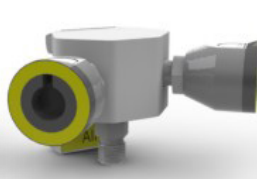

1225-005

- 1125-001 (1) 1/8" NPT Front
- 1125-011 (1) 1/8" NPT Front, DISS Side
- 1125-002 (1) DISS Front
- 1125-012 (1) DISS Front, DISS Side
- 1125-003 (1) Ohmeda Quick Connect Front
- 1125-013 (1) Ohmeda Quick Connect Front, DISS Side
- 1125-004 (1) Chemetron Quick Connect Front
- 1125-014 (1) Chemetron Quick Connect Front, DISS Side
- 1125-005 (1) Puritan Quick Connect Front
- 1125-015 (1) Puritan Quick Connect Front, DISS Side
  
- 1225-001 (2) 1/8" NPT Front
- 1225-011 (2) 1/8" NPT Front, DISS Side
- 1225-111 (2) 1/8" NPT Front, (2) DISS Side, Top Feed
- 1225-002 (2) DISS Front
- 1225-012 (2) DISS Front, DISS Side
- 1225-003 (2) Ohmeda Quick Connect Front
- 1225-013 (2) Ohmeda Quick Connect Front, DISS Side
- 1225-004 (2) Chemetron Quick Connect Front
- 1225-014 (2) Chemetron Quick Connect Front, DISS Side
- 1225-005 (2) Puritan Quick Connect Front
- 1225-015 (2) Puritan Quick Connect Front, DISS Side

To place an order for any of the above products, please contact a sales representative at 678.578.7800 or email at [orders@nexspan.com](mailto:orders@nexspan.com)

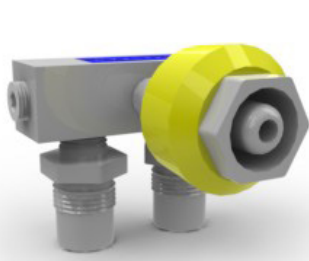

1006-016

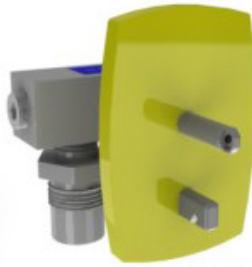

1006-008

## Air Outlet Splitter Blocks

- 1006-016 **DISS to (2) DISS Outlets**
- 1006-008 **Chemetron Quick Connect to (2) DISS Outlets**
- 1006-005 **Ohmeda Quick Connect to (2) DISS Outlets**
- 1006-021 **Puritan Quick Connect to (2) DISS Outlets**

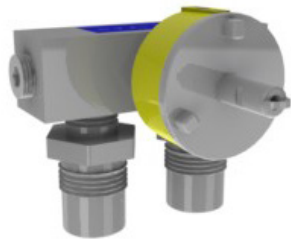

1006-005



1006-021

## Air Hoses



1007-303



1007-012

- 1007-003 **DISS to DISS Handnut Straight**  
(24", Clear, Non-Conductive)
- 1007-303 **DISS Straight to DISS Handnut with 90° Fitting**  
(24", Clear, Non-Conductive)
- 1007-010 **DISS to Ohmeda Style Quick Connect with 90° Fitting**  
(24", Clear, Non-Conductive)
- 1007-011 **DISS to Chemetron Style Quick Connect with 90° Fitting**  
(24", Clear, Non-Conductive)
- 1007-012 **DISS to Puritan Style Quick Connect with 90° Fitting**  
(24", Clear, Non-Conductive)
- 1007-103 **DISS to DISS Handnut Straight** (36", Clear, Non-Conductive)
- 1007-118 **DISS to DISS with 90° Fitting** (36", Clear, Non-Conductive)
- 1007-122 **DISS to DISS Straight** (36", Clear, Non-Conductive)
- 1007-110 **DISS to Ohmeda Style Quick Connect with 90° Fitting**  
(36", Clear, Non-Conductive)

To place an order for any of the above products, please contact a sales representative at 678.578.7800 or email at [orders@nexspan.com](mailto:orders@nexspan.com)

## Air Hoses (continued)



- 1007-111 **DISS to Chemetron Style Quick Connect with 90° Fitting**  
(36", Clear, Non-Conductive)
- 1007-112 **DISS to Puritan Style Quick Connect with 90° Fitting**  
(36", Clear, Non-Conductive)
- 1007-203 **DISS to DISS Handnut Straight** (48", Clear, Non-Conductive)
- 1007-218 **DISS to DISS with 90°** (48", Clear, Non-Conductive)
- 1007-323 **DISS Straight to DISS Handnut with 90° Fitting**  
(48", Clear, Non-Conductive)
- 1007-210 **DISS to Ohmeda Style Quick Connect with 90° Fitting**  
(48", Clear, Non-Conductive)
- 1007-211 **DISS to Chemetron Style Quick Connect with 90° Fitting**  
(48", Clear, Non-Conductive)
- 1007-212 **DISS to Puritan Style Quick Connect with 90° Fitting**  
(48", Clear, Non-Conductive)

## Vacuum Gas Blocks



- 1115-001 **(1) 1/8" NPT Front**
- 1115-002 **(1) DISS Front**
- 1115-003 **(1) Ohmeda Quick Connect Front**
- 1115-004 **(1) Chemetron Quick Connect Front**
- 1115-005 **(1) Puritan Quick Connect Front**

To place an order for any of the above products, please contact a sales representative at 678.578.7800 or email at [orders@nexspan.com](mailto:orders@nexspan.com)



1215-001



1215-002

### Vacuum Gas Blocks (continued)

- 1215-001 (2) 1/8" NPT Front
- 1215-002 (2) DISS Front
- 1215-003 (2) Ohmeda Quick Connect Front
- 1215-004 (2) Chemetron Quick Connect Front
- 1215-005 (2) Puritan Quick Connect Front



1215-003

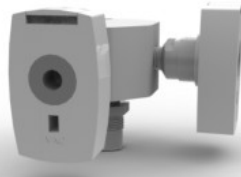

1215-004



1215-005



1006-018



1006-012

### Vacuum Wall Outlet Splitters

- 1006-018 DISS to (2) DISS Outlets
- 1006-012 Chemetron Quick Connect to (2) DISS Outlets
- 1006-011 Ohmeda Quick Connect to (2) DISS Outlets
- 1006-020 Splitter Block, Vacuum, Puritan QC to (2) DISS Outlets



1006-011

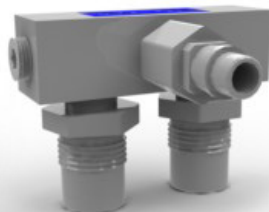

1006-020

To place an order for any of the above products, please contact a sales representative at 678.578.7800 or email at [orders@nexspan.com](mailto:orders@nexspan.com)

## Vacuum Hoses

- 1007-002 **DISS to DISS Handnut Straight**  
(24", Clear, Non-Conductive)
- 1007-302 **DISS Straight to DISS Handnut with 90° Fitting**  
(24", Clear, Non-Conductive)
- 1007-007 **DISS to Ohmeda Style Quick Connect with 90° Fitting**  
(24", Clear, Non-Conductive)
- 1007-008 **DISS to Chemetron Style Quick Connect with 90° Fitting**  
(24", Clear, Non-Conductive)
- 1007-009 **DISS to Puritan Style Quick Connect with 90° Fitting**  
(24", Clear, Non-Conductive)
- 1007-102 **DISS to DISS Handnut Straight** (36", Clear, Non-Conductive)
- 1007-312 **DISS Straight to DISS Handnut with 90° Fitting**  
(36", Clear, Non-Conductive)
- 1007-119 **DISS to DISS with 90° Fitting** (36", Clear, Non-Conductive)
- 1007-123 **DISS to DISS Straight** (36", Clear Non-Conductive)
- 1007-107 **DISS to Ohmeda Style Quick Connect with 90° Fitting**  
(36", Clear, Non-Conductive)
- 1007-108 **DISS to Chemetron Style Quick Connect with 90° Fitting**  
(36", Clear, Non-Conductive)
- 1007-109 **DISS to Puritan Style Quick Connect with 90° Fitting**  
(36", Clear, Non-Conductive)
- 1007-219 **DISS to DISS with 90° Fitting** (48", Clear Non-Conductive)
- 1007-322 **DISS Straight to DISS Handnut with 90° Fitting**  
(48", Clear, Non-Conductive)
- 1007-202 **DISS to DISS Handnut Straight** (48", Clear, Non-Conductive)
- 1007-207 **DISS to Ohmeda Style Quick Connect with 90° Fitting**  
(48", Clear, Non-Conductive)
- 1007-208 **DISS to Chemetron Style Quick Connect with 90° Fitting**  
(48", Clear, Non-Conductive)
- 1007-209 **DISS to Puritan Style Quick Connect with 90° Fitting**  
(48", Clear, Non-Conductive)



To place an order for any of the above products, please contact a sales representative at 678.578.7800 or email at [orders@nexspan.com](mailto:orders@nexspan.com)

# Headwalls

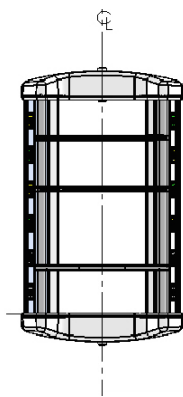

1024-XXX

**Matrixx M Vertical Headwall, custom services per signed submittal**

1024-XXX-M

**Matrixx M Vertical Headwall, custom services per signed submittal**

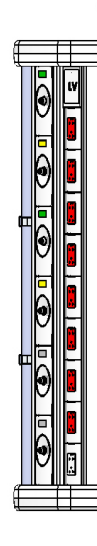

1023-XXX

**MGR Horizontal Headwall, custom services per signed submittal**

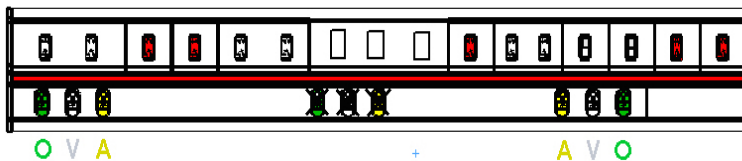

To place an order for any of the above products, please contact a sales representative at 678.578.7800 or email at [orders@nexspan.com](mailto:orders@nexspan.com)



## TAD™

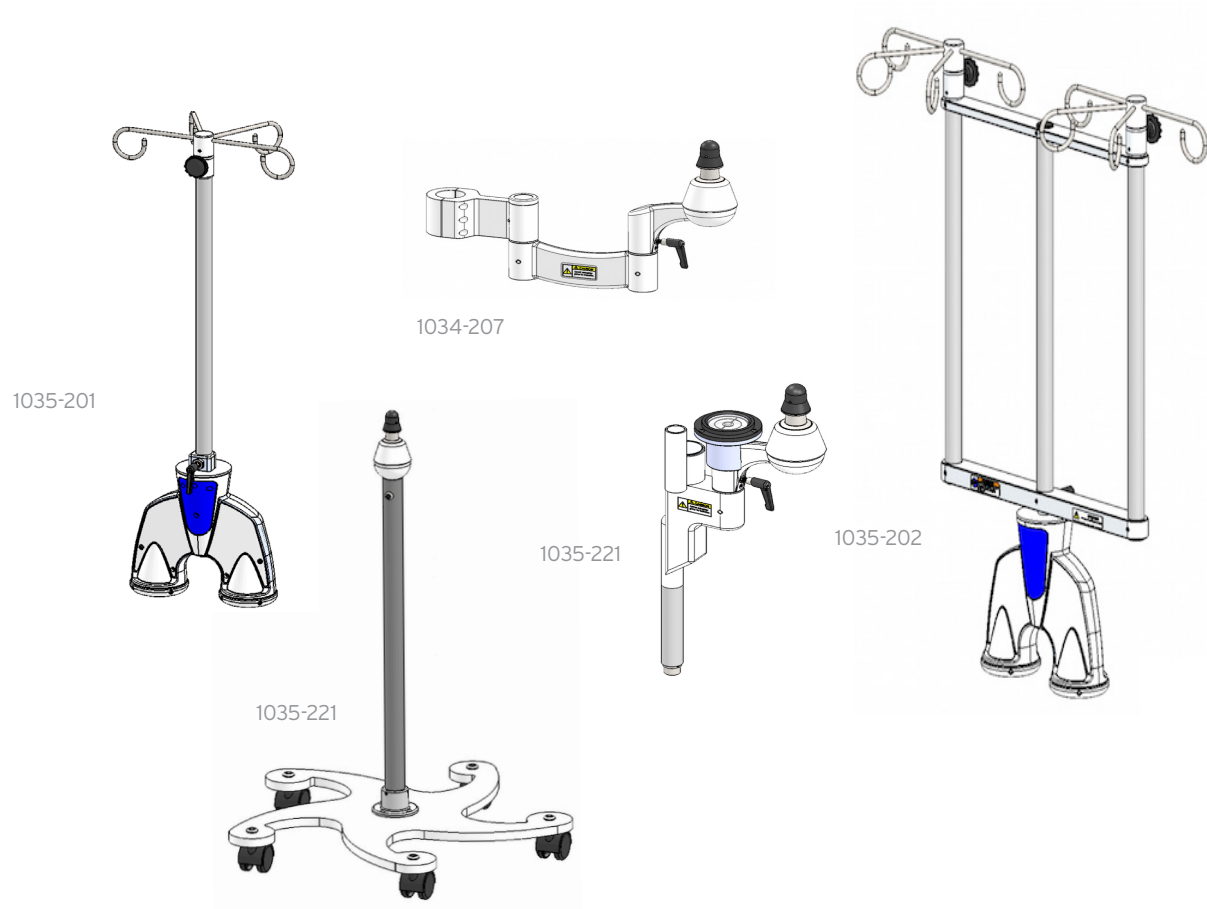

1035-201 **IV Transfer Device, w/Single IV Rack 19" Lg, extendable to 29" and (4) Hook Hangar**

1035-202 **IV Transfer Device, w/Dual IV Rack 19" Lg, extendable to 29" and (4) Hook Hangar**

1035-205 **TAD, Mobile Docking Station**

1035-207 **TAD, Mount for 38mm pole, w/ Arm & Cone (Call for other available mounting methods)**

1035-221 **Bed Arm, Styker InTouch 2.0 (Call for other available bed adapters)**

To place an order for any of the above products, please contact a sales representative at 678.578.7800 or email at [orders@nexspan.com](mailto:orders@nexspan.com)